



\*The images in this brochure are for reference only. The final model may vary slightly. We are continuously striving to improve our product.

- 

Display  
FHD Screen
- 

Auto dispense  
of Sanitizer
- 

Touch Screen  
Upgrade
- 

Integrates  
Wi-Fi
- 

HDMI Input
- 

Free Scheduling  
Software
- 

IPS panel  
Technology
- 

LED Backlight
- 

24/7 Usage
- 

Free Wall  
Mount
- 

Stand-alone version  
Android version  
Windows version
- 

Face  
recognition
- 

Mask  
detection

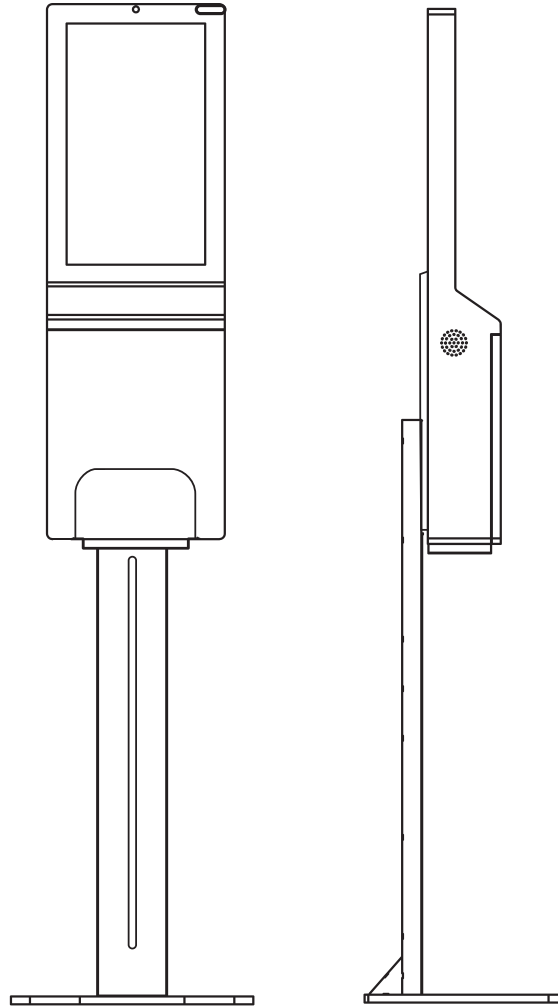

# ADV2152

# Multifunctions Kiosks

AUTOMATIC HAND SANITIZER AND SOAP DISPENSER 3L  
21.5 DIGITAL SIGNAGE, TEMPERATURE CHECK AND MORE





BASIC, MEDIUM AND FLAG & HIGH VERSIONS

# ADV2152 MULTIFUNCTIONS KIOSKS

## - FEATURES OVERVIEW

### Touch Screen

It has a 21.5 inch FHD screen with an Android 7.1/8.1 OS and waterproof Pro-cap touch function. So it can be used normally, even if your hand is wet. Supports both wall mount and freestanding install.

### Network CMS Upgrade

We also offer cloud basis network CMS if required, easy to control and management.

### Safe and Hygienic

You can use it for dispensing soap for handwashing or hand sanitising in the kitchen, the bathroom, at home, the office, public places and so on.

### Auto Touchless dispensing function

No contact and automatic dispense of Sanitizer or Soap with a hand motion. That eliminates a contact point and means fewer bacteria or virus and a cleaner surface for a longer time. Spray dosage 0.4 - 0.5 - 1.5 ml per (up to 4500 doses delivered per refill), Light indicator when consuming over 75% of sanitizer.

### Powerful Presentation app

Designed for use in commercial applications: this screen can run 24/7. There are no external buttons or controls to avoid tampering.

### Column design

Green light: Enough hand sanitizer above 10%;  
Blue light: Hand detection and sanitizer dispensation;  
Red light: Hand sanitizer level below 10%.

### Sustainable and Refillable

Zero plastic waste: we reuse our refill containers.  
Reduced wasting of disinfectant liquid thanks to an optimal dosage of 0.4 - 0.8ml. Rechargeable batteries.

### Drip tray

Less soiling around the disinfection unit.

### AI face recognition

20,000 faces storage and stanger detection.

### AI Temperature sensor

Passive multi-point temperature sensor.

### Optional OS

The screen could have both windows and android operating systems on it.

### IPS Panel

Superior image quality and colour depth at 178° ultra wide portrait orientations.

### Replacement Sanitizer

3L Sanitizer capacity. Open in the front for easy replacement sanitizer.

### Installation type

Supports both wall mount and floor standing installation with Height adjustment.

### Custom LOGO

Users can provide LOGO printing, door panels or other positions.

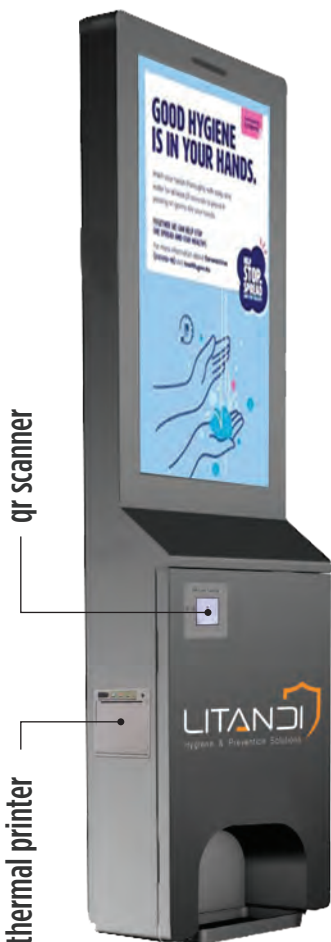

## ADV2152 MULTIFUNCTIONS KIOSKS - OPTIONS

Tailored-made applications software development

In addition to the basic features\*, ADV2152 kiosks offer the following optional functionalities: POS, QR code scanner, NFC card reader (13.56MHZ 14443 PROTOCOL IC card), Thermal printer (80mm paper), etc.

Thanks to SDK, customers can develop tailored-made applications according to their operational needs. For example: Self-service ordering food/ payment, queue management system, Registration to a service, Information help desk, etc.

\*Advertisement and Content display, Temperature measurement; Hand Sanitizer and Soap Dispenser.

## 18650 LITHIUM RECHARGEABLE BATTERY

ADV2152 supports a Lithium battery with charger:  
12V, 20A, 240W, 10-12 hours working time.



Technical features*	BASIC	MEDIUM	FLAG & HIGH
3000ML CAPACITY BOTTLE	✓	✓	✓
SANITIZER LEVEL	✓	✓	✓
SOFTWARE API SUPPORTING	✓	✓	✓
BRIGHTNESS OPTIONAL: 250 / 500 / 700 / 1000 NITS	✓	✓	✓
DISINFECTANT RESIDUE DETECTION SENSOR (SYNCHRONIZE LED LIGHT DISPLAY)	✓	✓	✓
CLOUD SERVICE OF CMS	✓	✓	✓
2.0 / 5.0 MP FRONT CAMERA	✓	✓	✓
FOAM / GEL / LIQUID NOZZLE SELECTABLE	✓	✓	✓
ANDROID OS /WINDOWS OS /STANDALONE	✓	✓	✓
A.I. TEMPERATURE SENSOR	✗	✓	✓
VIEW THE HAND SANITIZER DISPENSER USAGE (STATISTICS ON COMPUTER IN REAL TIME)	✗	✓	✗
EMAIL ALERTS ON NOTIFICATION WHEN LOW HAND	✗	✓	✗
PASSIVE MULTI-POINT TEMPERATURE SENSOR	✗	✗	✓
FACE RECOGNITION	✗	✗	✓
20,000 FACES STORAGE AND STRANGER DETECTION	✗	✗	✓
ATTENDANCE STATISTICS	✗	✗	✓
MASK DETECTION	✗	✗	✓

\*Technical features can be changed without notice.

## APPLICATIONS

ADV2152 Multifunctions Kiosks 3L Hand Sanitizer and Soap Dispenser is convenient for anyone: to deliver soap for handwashing or hand sanitising at home or in any public places. A Reliable and Cost-effective solution to help people keep their hands clean and safe. It supports both wall mount and floor standing installations.



SCHOOLS & UNIVERSITIES



AIRPORTS

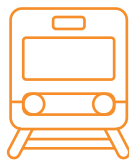

PUBLIC TRANSPORTATION



HOSPITALS



MALLS, STORES & MARKETS

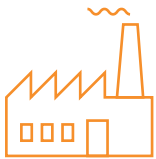

FACTORIES

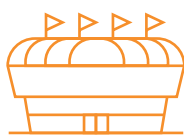

STADIUMS



PUBLIC SPACES



ARMY



EVENTS & CONFERENCES



SPORT VENUES, LEISURE & ENTERTAINMENT



PRIVATE & PUBLIC INSTITUTIONS



RESTAURANTS



SUPERMARKETS



BANKS

# EP380C THERMAL PRINTER - SPECIFICATIONS

Model	EP-380C	
Print	Print mode	Thermal line printing
	Print speed	Max: 200mm/s
	Resolution	203dpi(8dots/mm)
	Effective printing width	72mm
Character	Character set	ASC II,GB2312-80(Chinese),BIG5
	Print Font	ANK:9*17,12*24,GBK:24*24
	Character Flash	2M byte
	MCU	Flash:128KB SPAM:20KB
Paper spec.	Paper type	Thermal paper
	Paper diameter	13mm(Min),80mm(Max)
	Paper thickness	55-90µm
	Paper Width	79.5±0.5mm
Reliability	TPH	100km or more
	Cutter	1000000 cuts or more
Text and graphic support	Figure,sample,graph,curve icon,multi-languages	
Command	Compatible with ESC/POS command set	
Detectors	paper end,paper near end,paper out,paper taken out, cover open	
Cutting Method	Full/Partial cut	
Interface	Serial(RS232/TTL)+USB,Cash Drawer port(optional)	
Power Supply(Adapter)	DC24V-2A	
Barcode	1D	UPC-A, UPC-E, JAN/EAN8, JAN/EAN13, CODE39, ITF, CODEBAR, CODE128, CODE93
	2D	QR Code
Physical	Outline Dimension(W*L*H)	118.7*136.1*87.5mm
	Installation Port Size	113.7*131.1mm
	Insert Depth	95mm
	Color	Black/White
Environment	Operating	Temp:0 ~50
		Humidity:20%~85%
	Storage	Temp:-20 ~60
		Humidity:5%~90%

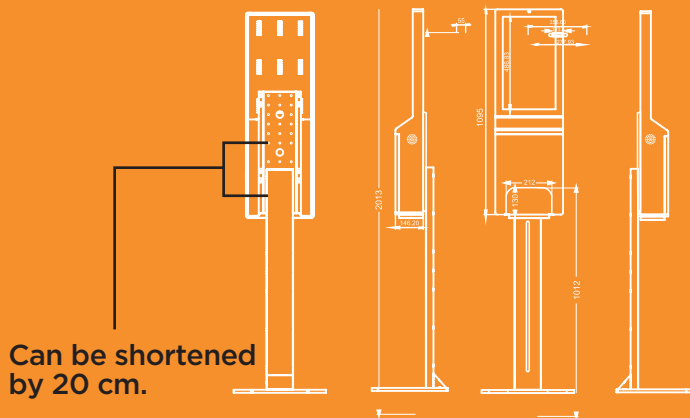

# TX SERIES | QR CODE SCANNERS

## SIZE PARAMETERS

Parameter Type	TX200	TX400	TX600	TX800
Physical dimension	95*84*48mm	95*70*48mm	134*92*50mm	88*67*48mm
Reading window size	59*46mm	59*46mm	59*46mm	59*46mm
Installation method	Embedded installation	External installation	Embedded installation	
Materials	ABS	ABS	ABS	ABS
Hole Size	67.5*88mm Corner radius 4.27mm	67.5*88mm Corner radius 4.27mm	108.2*86.2mm Corner radius 2.1mm	

## READING PARAMETERS

### TX series QR Code Reading parameters

Image Sensor	300,000 pixel CMOS (640*480)
Light source	Led diffuse lighting (white lighting, red indicator)
Instruction	Buzzer, three blue LED status indicators, red LED indication
Identification code	QR Code, Data Matrix, EAN_13, EAN_8, RSS_14, CODE_39, CODE_93, CODE_128, ITF, Code Bar, Inverse Code, Mirror Code, etc.
Print contrast	≥25%
Reading accuracy	≥7mil
Reading speed	70ms/times
Field of view angle	Horizontal field of view 77°, vertical field of view 60°
Reading angle	Tilt ± 40°, deflection ± 30°, rotate 360°
Depth of field	0mm~55mm ( 15mil QR Code )

## DEVICE PARAMETERS

Technical indicators	Specific parameters
Microprocessor	32-bit 1G CPU, high-speed DDR memory
Data interface	RS232 (9.6 ~ 115.2kbps), USB1.1 (HID-KBW, HID-POS), custom HID (add USB development interface, high-speed transmission)
Data line	RS232 data line (USB power supply interface + DB9 data interface), USB cable, TTL line
Operating temperature	-20~70 degrees Celsius
Storage temperature	-40 to 80 degrees Celsius
Humidity	Relative humidity 0%~95%
Ambient light intensity	0~80,000LUX
Operating Voltage	Supports 5~15V wide voltage input
Working current	0.15A (5V) or 0.05A (15v)
Maximum power Consumption	0.75W
International Certification	FCC Part15 Class B,CE EMC Class
Maintenance Requirements	Support remote maintenance and online upgrade
Materials	Body: Imported PC window: Tempered glass
Operating System	Supports Windows (xp.7.8.10), Linux, Android, Mac, etc.

# ADV2152 KIOSK | BASIC VERSION - SPECIFICATIONS

Model		Hand Sanitizing and Soap Dispenser	
Panel	Display Size (inch)	21.5" Full HD panel, LED backlight	
	Backlit Type	E-LED	
	Resolution	1920x1080	
	Active Display Area (mm)	474.64 (H)x 268.11 mm (V)	
	Aspect Ratio	16:09	
	Brightness (cd / m <sup>2</sup> )	250cd / m <sup>2</sup> options 500 / 700 / 1000cd / m <sup>2</sup>	
	Contrast Ratio (Typ.)	3000 : 1	
	Display Mode	Normal black, IPS	
	Display Color	10bit Dithering - 10.07 Billion	
	Viewing Angle (H / V)	89 / 89 / 89 / 89 (L / R / U / D)	
	Color	16.7m	
	Response Time (G-to-G)	6ms	
	Operation Hour	24 / 7	
Sound	Audio Output	Built - in speaker 8 Ohm / 3 watt *2 pcs.	
Power	Type	Internal	
	Power Supply	AC 100 - 240 V~ (+/- 10 %), 50 / 60 Hz	
	Power Consumption	Max [W / h]	60
		Sleep Mode	less than 0.5W
	Off Mode	less than 0.5W	
Mechanical Specs.	Protection Glass	Yes	
	Mount Type	Wallmount / Floor standing (optional)	
Environmental	Operating Temperature	15° C ~ 35° C	
	Storage Temperature	-10° C ~ 55° C	
	Operating Humidity	10 - 80%	
	Storage Humidity	5% ~ 95%	
OS	Android Media Player	Processor	C800 / V56 / PX30 / RK3288 / RK3399 / i3 / i5 / i7
		RAM	1 GB / 2GB / 4GB / 8GB
		Memory	8GB / 16GB / 32GB / 64GB / 128GB / 256GB
		Connections	Ethernet (RJ45), WiFi [Bluetooth, 4G (Optional)]
		LAN	10M / 100M Ethernet (Network version screen only)
		Interface	USB2.0*2, RJ-45*1, SD socket*1, Audio*1
		Multimedia	Video (MPG, AVI, MP4, RM, RMVB, TS), Audio (MP3, WMA), Image (JPG, GIF, BMP, PNG)
		Media Resolution	1920*1080
		Wi-Fi	802.11b / g/n Ethernet (Network version screen only)
		Android Version / Language	Android 8.1   English (Default) - Multi-language
Sanitizer Dispensing	Dispensing Sanitizer	Auto dispense of Sanitizer or Soap with hand motion	
	Sanitizer Capacity	3000ml capacity of Sanitizer Content	
	Light Indicator	Green: level more than 10% and stand by; Red: lower than 10%; Blue: hand disinfection	
Appearance	Color	White Color (standard) - Customized colors based on MOQ	
	Surface Treatment	Powder Coated	
	Shell Material	Tempered Glass face & Cold rolled Aluminium Sheet Body	
	Installation	Wallmount - Floor Standing Base (optional)	
	Screen Position	Vertical	
Certification	Safety	CE ROHS FCC	
Accessories	Include	Keys, Wallmount bracket, Screws, Power Cable, Wi-Fi Antenna	
	Quality Assurance	2 Years Warranty	
	Type of Packaging	PE film + Foam corner protector + Carton or Honeycomb Box	

# ADV2152 KIOSK | MEDIUM VERSION - SPECIFICATIONS

Model		Hand Sanitizing Dispenser	
Panel	Display Size (inch)	21.5" Full HD panel, LED backlight	
	Backlit Type	E-LED	
	Resolution	1920x1080	
	Active Display Area (mm)	474.64 (H)x 268.11 mm (V)	
	Aspect Ratio	16:09	
	Brightness (cd / m <sup>2</sup> )	250cd / m <sup>2</sup> options 500 / 700 / 1000cd / m <sup>2</sup>	
	Contrast Ratio (Typ.)	3000 : 1	
	Display Mode	Normal black, IPS	
	Display Color	10bit Dithering - 10.07 Billion	
	Viewing Angle (H / V)	89 / 89 / 89 / 89 (L / R / U / D)	
	Color	16.7m	
	Response Time (G-to-G)	6ms	
	Operation Hour	24 / 7	
Sound	Audio Output	Built - in speaker 8 Ohm / 3 watt *2 pcs.	
Power	Type	Internal	
	Power Supply	AC 100 - 240 V~ (+/- 10 %), 50 / 60 Hz	
	Power Consumption	Max [W / h]	60
		Sleep Mode	less than 0.5W
	Off Mode	less than 0.5W	
Mechanical Specs.	Protection Glass	Yes	
	Mount Type	Wallmount / Floor standing (optional)	
Environmental	Operating Temperature	15° C ~ 35° C	
	Storage Temperature	-10° C ~ 55° C	
	Operating Humidity	10 - 80%	
	Storage Humidity	5% ~ 95%	
OS	Android Media Player	Processor	Rockchip RK-PX30 ( Cortex-A35 Mali-G31 MP2 GPU)
		RAM	1 GB DDR
		Memory	Built-in FLASH memory 8G
		Connections	Ethernet (RJ45), WiFi [Bluetooth, 4G (Optional)]
		LAN	10M / 100M Ethernet (Network version screen only)
		Interface	USB2.0*2, RJ-45*1, SD socket*1, Audio*1
		Multimedia	Video (MPG, AVI, MP4, RM, RMVB, TS), Audio (MP3, WMA), Image (JPG, GIF, BMP, PNG)
		Media Resolution	1920*1080
		Wi-Fi	802.11b / g/n Ethernet (Network version screen only)
		Android Version / Language	Android 8.1   English (Default) - Multi-language
Sanitizer Dispensing	Dispensing Sanitizer	Auto dispense of Sanitizer or Soap with hand motion	
	Sanitizer Capacity	3000ml capacity of Sanitizer Content	
	Light Indicator	Green: level more than 10% and stand by; Red: lower than 10%; Blue: hand disinfection	
Appearance	Color	White Color (standard) - Customized colors based on MOQ	
	Surface Treatment	Powder Coated	
	Shell Material	Tempered Glass face & Cold rolled Aluminium Sheet Body	
	Installation	Wallmount - Floor Standing Base (optional)	
	Screen Position	Vertical	
Certification	Safety	CE ROHS FCC	
Accessories	Include	Keys, Wallmount bracket, Screws, Power Cable, Wi-Fi Antenna	
	Quality Assurance	2 Years Warranty	
	Type of Packaging	PE film + Foam corner protector + Carton or Honeycomb Box	



# ADV2152 KIOSK | FLAG & HIGH VERSION - SPECIFICATIONS

Model		Hand Sanitizing Dispenser	
Panel	Display Size (inch)	21.5" Full HD panel, LED backlight	
	Backlit Type	E-LED	
	Resolution	1920x1080	
	Active Display Area (mm)	474.64 (H)x 268.11 mm (V)	
	Aspect Ratio	16:09	
	Brightness (cd / m <sup>2</sup> )	250cd / m <sup>2</sup> options 500 / 700 / 1000cd / m <sup>2</sup>	
	Contrast Ratio (Typ.)	3000 : 1	
	Display Mode	Normal black, IPS	
	Display Color	10bit Dithering - 10.07 Billion	
	Viewing Angle (H / V)	89 / 89 / 89 / 89 (L / R / U / D)	
	Color	16.7m	
	Response Time (G-to-G)	6ms	
	Operation Hour	24 / 7	
Sound	Audio Output	Built - in speaker 8 Ohm / 3 watt *2 pcs.	
Power	Type	Internal	
	Power Supply	AC 100 - 240 V- (+/- 10 %), 50 / 60 Hz	
	Power Consumption	Max [W / h]	60
		Sleep Mode	less than 0.5W
	Off Mode	less than 0.5W	
Mechanical Specs.	Protection Glass	Yes	
	Mount Type	Wallmount / Floor standing (optional)	
Environmental	Operating Temperature	15° C ~ 35° C	
	Storage Temperature	-10° C ~ 55° C	
	Operating Humidity	10 ~ 80%	
	Storage Humidity	5% ~ 95%	
OS	Android Media Player	Processor	Rockchip Rk3288
		RAM	2 GB DDR
		Memory	Built-in FLASH memory 16G
		Connections	Ethernet (RJ45), WiFi [Bluetooth, 4G (Optional)]
		LAN	10M / 100M Ethernet (Network version screen only)
		Interface	USB2.0*2, RJ-45*1, SD socket*1, Audio*1
		Multimedia	Video (MPG, AVI, MP4, RM, RMVB, TS), Audio (MP3, WMA), Image (JPG, GIF, BMP, PNG)
		Media Resolution	1920*1080
		Wi-Fi	802.11b / g/n Ethernet (Network version screen only)
		Android Version / Language	Android 7.1   English (Default) - Multi-language
Sanitizer Dispensing	Dispensing Sanitizer	Auto dispense of Sanitizer or Soap with hand motion	
	Sanitizer Capacity	3000ml capacity of Sanitizer Content	
	Light Indicator	Green: level more than 10% and stand by; Red: lower than 10%; Blue: hand disinfection	
Appearance	Color	White Color (standard) - Customized colors based on MOQ	
	Surface Treatment	Powder Coated	
	Shell Material	Tempered Glass face & Cold rolled Aluminium Sheet Body	
	Installation	Wallmount - Floor Standing Base (optional)	
	Screen Position	Vertical	
Certification	Safety	CE ROHS FCC	
Accessories	Include	Keys, Wallmount bracket, Screws, Power Cable, Wi-Fi Antenna	
	Quality Assurance	2 Years Warranty	
	Type of Packaging	PE film + Foam corner protector + Carton or Honeycomb Box	

# ADV2152 Multifunctions Kiosks

Automatic Hand Sanitizer and Soap Dispenser 3L  
21.5 Digital Signage, Temperature Check and more

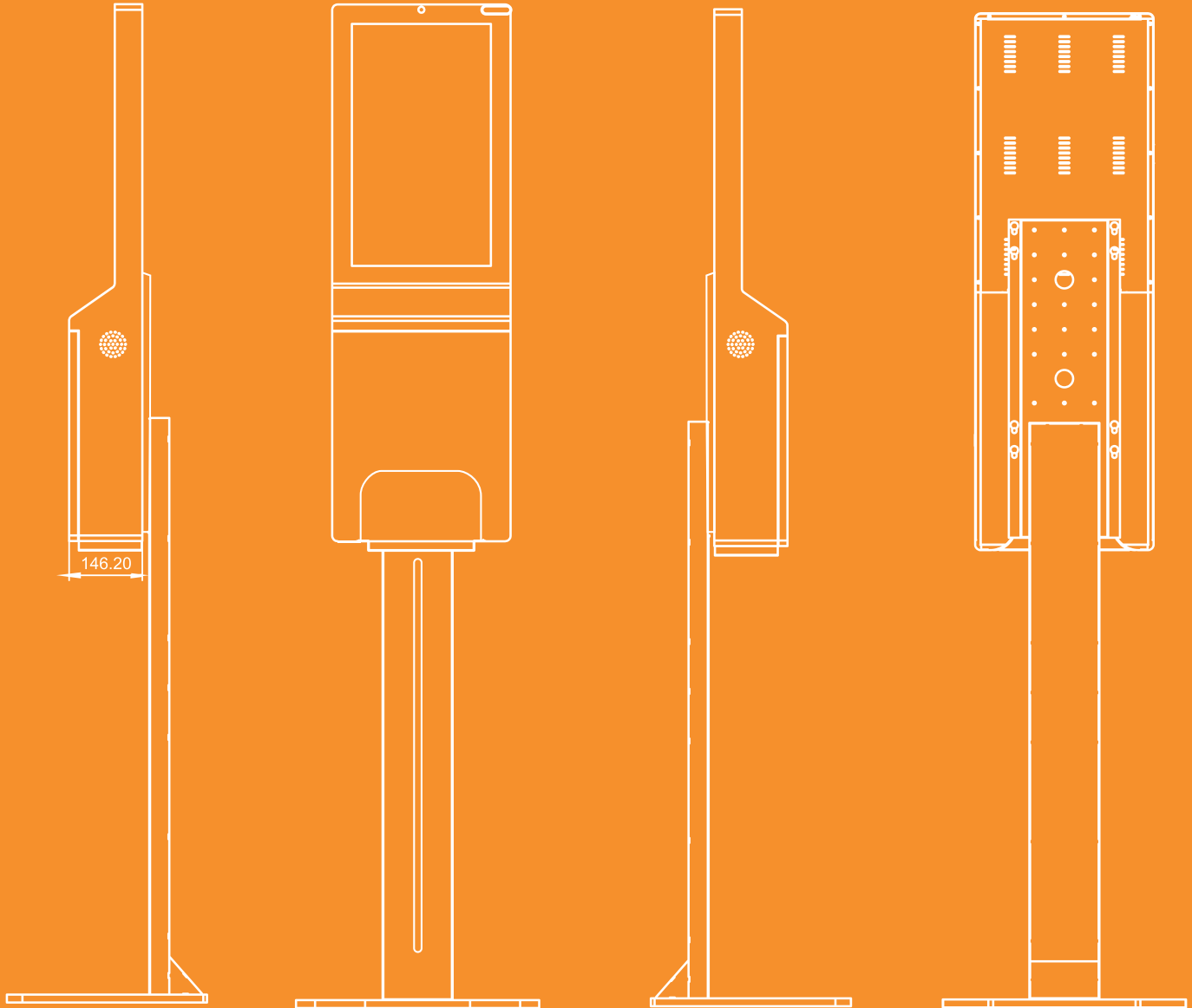

This symbol on a product or in the instruction manual means that your electrical and electronic equipment should be separated from your household waste at the end of its life. There is a separate recycling system in your country for recycling. For more information, contact the place where you purchased the product or your retailer.

[litandisolutions.com](http://litandisolutions.com)  
[contact@litandisolutions.com](mailto:contact@litandisolutions.com)